



# HEAVY DUTY KEY SWITCH

## Large Format Inter-changeable Core Cylinder



CATALOG  
V-003





# HEAVY DUTY KEY SWITCH

## Large Format Inter-changeable Core Cylinder



COMPATIBLE  
**Schlage**

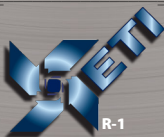



CATALOG

V-003

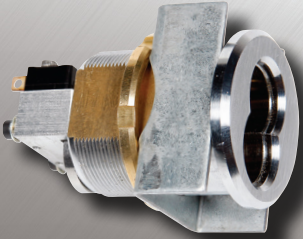

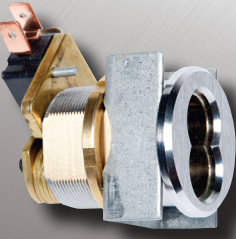
 <h3>ICSC01A1</h3> 	<b>SWITCH TYPE</b> SPDT (Single pole – Double Throw)	<b>SWITCH ACTION</b> Momentary on-on	<b>KEY ROTATION</b> 30° Clockwise-on
	<b>CONTACT RATING</b> 10A 125vac, 10A 250vac Resistive		<b>FINISHES</b> BHMA 626, 613 & 606
	<b>PANEL MOUNT PREPARATION</b> Large Cam Lock Style 1-5/32"dia by .950" (flat width) Double "D" Design		

 <h3>ICSC01B1</h3> 	<b>SWITCH TYPE</b> B1-SPDT (Single pole – Double Throw)	<b>SWITCH ACTION</b> Momentary on-on	<b>KEY ROTATION</b> 45° Clockwise-on
	<b>CONTACT RATING</b> 15A 125vac, 15A 250vac Resistive		<b>FINISHES</b> BHMA 626, 613 & 606
	<b>PANEL MOUNT PREPARATION</b> Large Cam Lock Style 1-5/32"dia by .950" (flat width) Double "D" Design		

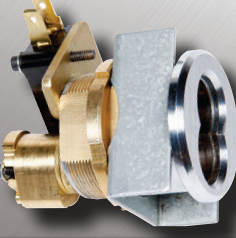
 <h3>ICSC01B2</h3> 	<b>SWITCH TYPE</b> B2-SPDT (Single pole – Double Throw)	<b>SWITCH ACTION</b> Maintained on-on	<b>KEY ROTATION</b> 360° Clockwise-on
	<b>CONTACT RATING</b> 15A 125vac, 15A 250vac Resistive		<b>FINISHES</b> BHMA 626, 613 & 606
	<b>PANEL MOUNT PREPARATION</b> Large Cam Lock Style 1-5/32"dia by .950" (flat width) Double "D" Design		

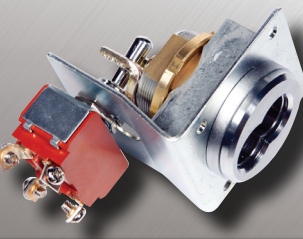
 <h3>ICSC01D2</h3> 	<b>SWITCH TYPE</b> DPST (Double pole – Single Throw)	<b>SWITCH ACTION</b> Maintained on-off	<b>KEY ROTATION</b> 25° Clockwise-on, 25° Counter Clockwise-off
	<b>CONTACT RATING</b> 15A 125vac, 15A 250vac, DC30v 15A Resistive		<b>FINISHES</b> BHMA 626, 613 & 606
	<b>PANEL MOUNT PREPARATION</b> Large Cam Lock Style 1-5/32"dia by .950" (flat width) Double "D" Design		

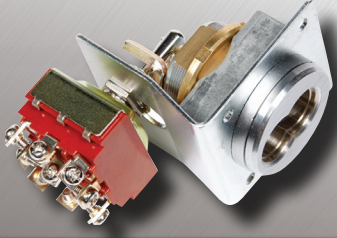
 <h3>ICSC01E2</h3> 	<b>SWITCH TYPE</b> TPDT (Triple pole – Double Throw)	<b>SWITCH ACTION</b> Maintained on-center off-on	<b>KEY ROTATION</b> 30° Clockwise-on, 30° Counter Clockwise-on
	<b>CONTACT RATING</b> 25A 125vac, 9A 250vac, 20A 30vdc Resistive		<b>FINISHES</b> BHMA 626, 613 & 606
	<b>PANEL MOUNT PREPARATION</b> Large Cam Lock Style 1-5/32"dia by .950" (flat width) Double "D" Design		



# HEAVY DUTY KEY SWITCH

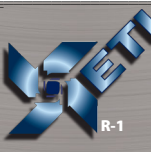

## Large Format Inter-changeable Core Cylinder





CATALOG

V-003

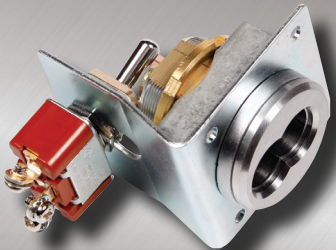

 <h2>ICSC01K4</h2> 	<b>SWITCH TYPE</b> DPDT (Double pole – Double Throw)	<b>SWITCH ACTION</b> Momentary on-center off-on	<b>KEY ROTATION</b> 24° Clockwise-on, 24° Counter Clockwise-on
	<b>CONTACT RATING</b> 15A 125vac, 15A 250vac Resistive, Motor Load 400w 125vac		<b>FINISHES</b> BHMA 626, 613 & 606
	<b>PANEL MOUNT PREPARATION</b> Large Cam Lock Style 1-5/32"dia by .950" (flat width) Double "D" Design		

<b>SWITCH TYPE</b> SPDT (Single pole – Double Throw)	<b>SWITCH ACTION</b> Maintained on-on	<b>KEY ROTATION</b> 32° Clockwise-on, 32° Counter Clockwise-on	<h2>ICSC01L2</h2>  
<b>CONTACT RATING</b> 15A 125vac, 6A 250vac, 20A 30vdc Resistive		<b>FINISHES</b> BHMA 626, 613 & 606	
<b>PANEL MOUNT PREPARATION</b> Large Cam Lock Style 1-5/32"dia by .950" (flat width) Double "D" Design			

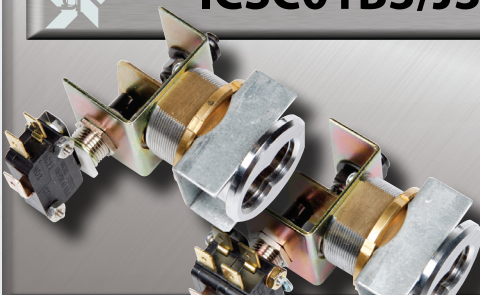
 <h2>ICSC01B3/J3</h2> 	<b>SWITCH TYPE</b> B3-SPDT (Single pole – Double Throw)	<b>SWITCH ACTION</b> Momentary on-on	<b>KEY ROTATION</b> 30° Clockwise-on
	<b>CONTACT RATING</b> 10A 125vac, 10A 250vac Resistive		<b>FINISHES</b> BHMA 626, 613 & 606
	<b>PANEL MOUNT PREPARATION</b> Large Cam Lock Style 1-5/32"dia by .950" (flat width) Double "D" Design <b>MODEL:</b> J-3 (2) SPDT Switches (Single Pole – Double Pole)		

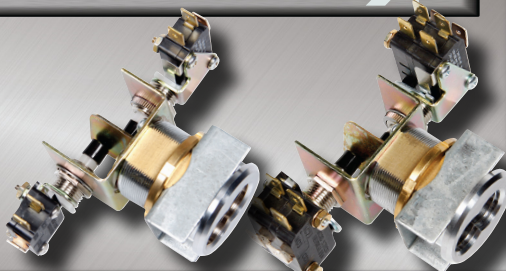
<b>SWITCH TYPE</b> P2-(4) SPDT (Single pole – Double Throw)	<b>SWITCH ACTION</b> Momentary on-on	<b>KEY ROTATION</b> 30° Clockwise-on, 30° Counter Clockwise-on	<h2>ICSC01P2/R4</h2>  
<b>CONTACT RATING</b> 15A 125vac, 15A 250vac Resistive		<b>FINISHES</b> BHMA 626, 613 & 606	
<b>PANEL MOUNT PREPARATION</b> Large Cam Lock Style 1 5/32"dia by .950" (flat width) Double "D" Design <b>MODEL:</b> R-4 (4) SPDT Switches (Single Pole – Double Pole)			



**OPTIONS:**

**FACEPLATES**



**Narrow Faceplate**  
option **0**

(for models A1, B1, B2, B3, D2, E2, J3, K4, L2, only)



**Single Gang Faceplate**  
option **1**



**Double Gang Faceplate**  
with single switch  
option **2**

(for models A1, B1, B2, B3, D2, E2, J3, K4, L2, only)



**Double Gang Faceplate**  
with double switch  
option **3**

(for models A1, B1, B2, B3, J3 only)

**FINISHES**

Satin Chrome  
**BHMA 626**  
option **S**

Oiled Rubbed Bronze  
**BHMA 613**  
option **D**

Satin Brass  
**BHMA 606**  
option **B**

**FINISHES**

**RED (1)**  
12/24 volt, mounted  
option **R**

**GREEN (1)**  
12/24 volt, mounted  
option **G**

**RED (1) & GREEN (1)**  
12/24 volt, mounted  
option **T**

**SWITCH ACTION & FUNCTION**

MODEL	SPDT 10 AMP ON-ON	SPDT 15 AMP ON-ON	DPDT 15 AMP ON-ON	DPST 15 AMP ON-OFF	3PDT 15 AMP ON-OFF-ON	DPDT 15 AMP ON-OFF-ON	SPDT 15 AMP ON-OFF-ON																																																																						
<b>ICSC01A1</b>	<table border="1"> <thead> <tr> <th colspan="5">FACEPLATE Switch &amp; Configuration</th> </tr> <tr> <th>MODEL</th> <th>SINGLE SWITCH</th> <th>SINGLE SWITCH</th> <th>SINGLE SWITCH</th> <th>DOUBLE SWITCH</th> </tr> <tr> <th></th> <th>NARROW SWITCH PLATE</th> <th>SINGLE GANG SWITCH PLATE</th> <th>DOUBLE GANG SWITCH PLATE</th> <th>DOUBLE GANG SWITCH PLATE</th> </tr> </thead> <tbody> <tr><td>ICSC01A1</td><td>X</td><td>X</td><td>X</td><td>X</td></tr> <tr><td>ICSC01B1</td><td>X</td><td>X</td><td>X</td><td>X</td></tr> <tr><td>ICSC01B2</td><td>X</td><td>X</td><td>X</td><td>X</td></tr> <tr><td>ICSC01B3</td><td>X</td><td>X</td><td>X</td><td>X</td></tr> <tr><td>ICSC01J3</td><td>X</td><td>X</td><td>X</td><td>X</td></tr> <tr><td>ICSC01D2</td><td></td><td>X</td><td>X</td><td></td></tr> <tr><td>ICSC01E2</td><td></td><td>X</td><td>X</td><td></td></tr> <tr><td>ICSC01K4</td><td></td><td>X</td><td>X</td><td></td></tr> <tr><td>ICSC01L2</td><td></td><td>X</td><td>X</td><td></td></tr> <tr><td>ICSC01P2</td><td></td><td></td><td>PANEL ONLY</td><td></td></tr> <tr><td>ICSC01R4</td><td></td><td></td><td>PANEL ONLY</td><td></td></tr> </tbody> </table>							FACEPLATE Switch & Configuration					MODEL	SINGLE SWITCH	SINGLE SWITCH	SINGLE SWITCH	DOUBLE SWITCH		NARROW SWITCH PLATE	SINGLE GANG SWITCH PLATE	DOUBLE GANG SWITCH PLATE	DOUBLE GANG SWITCH PLATE	ICSC01A1	X	X	X	X	ICSC01B1	X	X	X	X	ICSC01B2	X	X	X	X	ICSC01B3	X	X	X	X	ICSC01J3	X	X	X	X	ICSC01D2		X	X		ICSC01E2		X	X		ICSC01K4		X	X		ICSC01L2		X	X		ICSC01P2			PANEL ONLY		ICSC01R4			PANEL ONLY	
FACEPLATE Switch & Configuration																																																																													
MODEL	SINGLE SWITCH	SINGLE SWITCH	SINGLE SWITCH	DOUBLE SWITCH																																																																									
	NARROW SWITCH PLATE	SINGLE GANG SWITCH PLATE	DOUBLE GANG SWITCH PLATE	DOUBLE GANG SWITCH PLATE																																																																									
ICSC01A1	X	X	X	X																																																																									
ICSC01B1	X	X	X	X																																																																									
ICSC01B2	X	X	X	X																																																																									
ICSC01B3	X	X	X	X																																																																									
ICSC01J3	X	X	X	X																																																																									
ICSC01D2		X	X																																																																										
ICSC01E2		X	X																																																																										
ICSC01K4		X	X																																																																										
ICSC01L2		X	X																																																																										
ICSC01P2			PANEL ONLY																																																																										
ICSC01R4			PANEL ONLY																																																																										
	MONENTARY DETENT ACTION 30 DEGREE RIGHT ROTATION																																																																												
<b>ICSC01B1</b>	MONENTARY DETENT ACTION 45 DEGREE RIGHT ROTATION																																																																												
<b>ICSC01B2</b>	MAINTAINED 360 DEGREE RIGHT ROTATION																																																																												
<b>ICSC01B3</b>	MONENTARY SPRING ACTION 30 DEGREE RIGHT ROTATION																																																																												
<b>ICSC01J3</b>	MONENTARY SPRING ACTION 30 DEGREE RIGHT ROTATION																																																																												
<b>ICSC01D2</b>	MAINTAINED RIGHT / LEFT TOGGLE ACTION																																																																												
<b>ICSC01E2</b>	MONENTARY RIGHT / CTR / LEFT TOGGLE ACTION																																																																												
<b>ICSC01K4</b>	MONENTARY RIGHT / CTR / LEFT TOGGLE ACTION																																																																												
<b>ICSC01L2</b>	MAINTAINED RIGHT / LEFT TOGGLE ACTION																																																																												
<b>ICSC01P2</b>	MONENTARY SPRING ACTION 30 DEGREE RIGHT / CTR / LEFT ROTATION																																																																												
<b>ICSC01R4</b>	MONENTARY SPRING ACTION 30 DEGREE RIGHT / CTR / LEFT ROTATION																																																																												

